

COMPACTA 5M-6T

RESIDUAL . SEWAGE . RÉSIDUAIRES



Sumergibles para Aguas Fecales Vortex. Submersible Vortex Pumps for Sewage Water

————— DNG 2" - 2850 1 / min

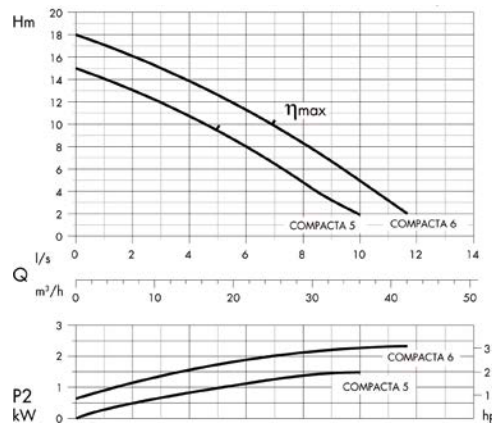

Aplicaciones:

Las robustas electrobombas portátiles de la serie compacta, que incorporan turbina desplazada tipo Vortex, están diseñadas específicamente para la evacuación de aguas cargadas que contengan bien gases o bien sólidos blandos en suspensión.

Son ideales para su uso en fosas sépticas, en la industria, en hospitales, etc. Debe trabajar con el motor al menos parcialmente sumergido.

Características Constructivas:

Cuerpo de la bomba, carcasa del motor, portacojinetes y tapa del motor en fundición de hierro GG25. Tornillería en acero inoxidable tipo A2. Juntas tóricas en nitrilo. Eje de la bomba en acero inoxidable AISI 420. Sello mecánico del lado de la bomba en carbono de silicio. El superior es un retén de aceite.

Atención: La bomba COMPACTA 5M AUT se entrega con interruptor de nivel (automático) suelto, que se debe conectar a la caja de conexiones incorporada de serie.

Motor:

Asíncrono a 2850 rpm monofásico y trifásico, aislamiento de clase F. Tiene un grado de protección IP-68 e incorpora motoprotector en el bobinado. Incluye de serie un cable H07RNF de 10 m. La temperatura máxima del agua en continuo es de +40 °C y en intermitente, de +80 °C. Valores de pH entre 6 y 11.



Applications:

The robust and portable compact series electric pumps, with set-back vortex impeller, are specially designed for the expulsion of water containing either gases or soft solids in suspension. They are ideal for use in septic tanks, industrial applications, hospitals, etc.

They must operate with the motor at least partially submerged.

Construction Features:

The body of the pump, motor casing, bearing housing and motor cover made from cast iron GG25. A2 stainless steel bolts, screws and fixings. Nitrile O-rings. Stainless steel (AISI 420) pump shaft. The mechanical seal on the side of the pump made from silicon carbide and on the top is an oil seal. *Warning: COMPACTA 5M AUT pump. Supplied with a separate level switch (automatic) that must be connected to the connection box built into the pump.*

Motor:

Asynchronous at 2850 rpm, single and triple phase, insulation class F. Protection grade IP68, incorporating motor protection in the winding. Series comes with 10 m of H07RNF cable. Maximum water temperature +40°C during continuous operation and +80°C during intermittent operation. Liquid pH values between 6 and 11.



Applications :

Les électropompes robustes et portables de la série compacte qui intègrent une turbine décalée de type Vortex sont spécifiquement prévues pour l'évacuation d'eaux chargées contenant des gaz ou des solides mous en suspension.

Elles conviennent parfaitement à l'utilisation dans des fosses septiques, industrielles, des hôpitaux, etc. En service, le moteur doit être au moins partiellement immergé.

Caractéristiques de Conception :

Corps de la pompe, carcasse du moteur, porte-coussinet et couvercle du moteur en fonte GG25. Boulonnerie en acier inoxydable de type A2. Joints toriques en nitrile. Axe de la pompe en acier inoxydable AISI 420. Garniture mécanique du côté de la pompe en carbone de silicium et récupérateur d'huile sur la partie supérieure. *Attention : La pompe COMPACTE 5M AUT est livrée avec un interrupteur de niveau (automatique) détaché, qui doit être connecté au boîtier de raccordement intégré de série.*

Moteur :

Asynchrone à 2 850 tours par minute monophasé et triphasé, isolation de classe F. Niveau de protection IP-68. Il est doté d'un motoprotecteur dans l'enroulement. Il vient en série avec 10 m de câble H07RNF. Température maximale de l'eau en continue +40 °C et + 80 °C en discontinue. Valeurs de Ph entre 6 et 11.

COMPACTA 5M-6T

RESIDUAL . SEWAGE . RÉSIDUAIRES

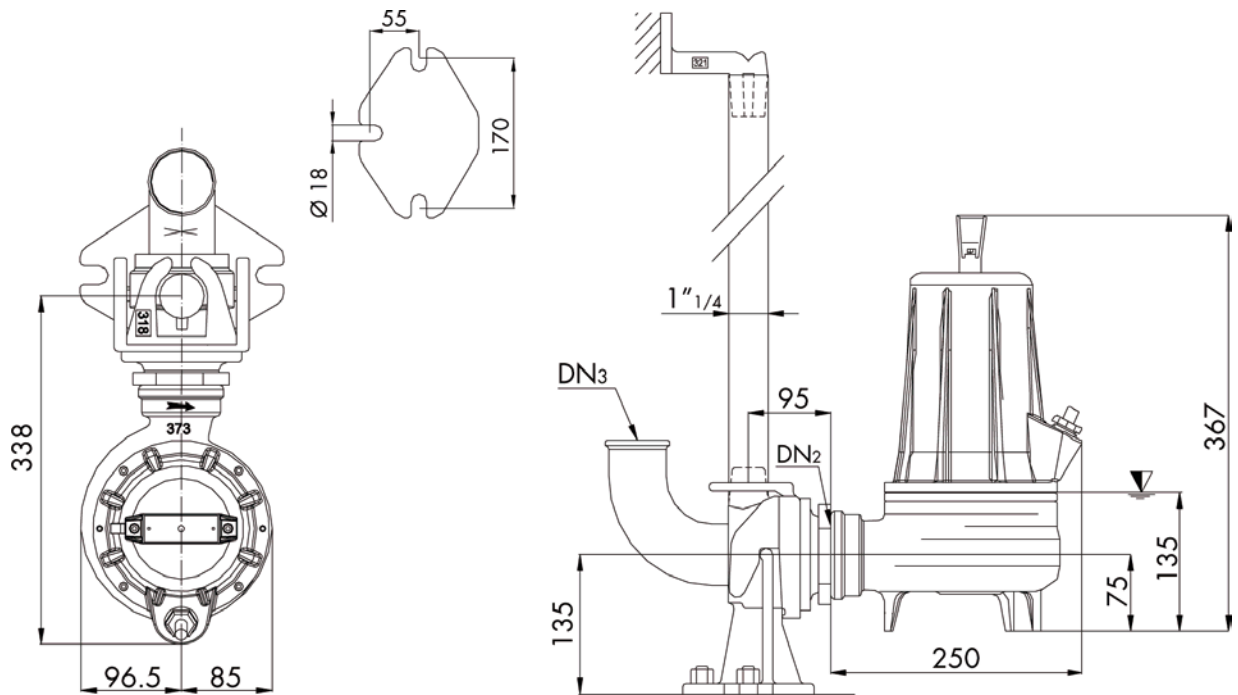





▼ Lowest shut-off point for automatic operation

Specifications:

| Type | Q | l/s | 2 | 3 | 4 | 5 | 6 | 7 | 8 | 10 | 11 |
|--------------|-----|-------------------|-----|------|------|------|------|------|------|-----|------|
| | | l/m | 120 | 180 | 240 | 300 | 360 | 420 | 480 | 600 | 660 |
| | | m ³ /h | 7,2 | 10,8 | 14,4 | 18 | 21,6 | 25,2 | 28,8 | 36 | 39,6 |
| COMPACTA 5 M | H m | | 13 | 12 | 10,6 | 9,5 | 8,0 | 6,5 | 5,0 | 2,0 | |
| COMPACTA 6 T | | | 16 | 15 | 14 | 12,5 | 11,2 | 10 | 8,3 | 5,0 | 3,0 |

| Type | Delivery | kW | | Hp | R.p.m. 1/min | Poles | Hz | A | | |
|--------------|------------|-----|-----|----|-----------------|-------|----|-------|----|-------|
| | | P1 | P2 | | | | | 1 ~ | | 3 ~ |
| | | | | | | | | 230 V | µf | 400 V |
| COMPACTA 5 M | Dn2 - G 2" | 1,9 | 1,5 | 2 | 2850 | 2 | 50 | 9,6 | 40 | |
| COMPACTA 6 T | | 2,6 | 2,2 | 3 | 2850 | 2 | 50 | | | 5,2 |

| TYPE | DN2 | DN3 | CABLE | | OPTIONAL | SEALS | | BEARINGS | |
|------------------------------|------|-----|---|---|---|---|---|---|------------|
| COMPACTA 5 M COMPACTA 6 T | G 2" | 2" | 1 ~ 230 V (1) 4x1,5+2x0,5 Ø 12 Control panel | 3 ~ 400 V (1) 4x1,5+2x0,5 Ø 12 with free terminals | MT 10  Type: B3 |  |  |  | |
| | | | | | | SUP./UPPER | INF./LOWER | SUP./UPPER | INF./LOWER |
| | | | | | | SC 15-24-5 | MG1S2/14 G1 | 6202 2Z | 6302 2Z |

| TYPE | X | Y | Z | KG |
|--------------|-----|-----|-----|------|
| COMPACTA 5 M | 230 | 450 | 270 | 24 |
| COMPACTA 6 T | 230 | 450 | 270 | 24,5 |



COMPACTA 5M-6T

RESIDUAL . SEWAGE . RÉSIDUAIRES

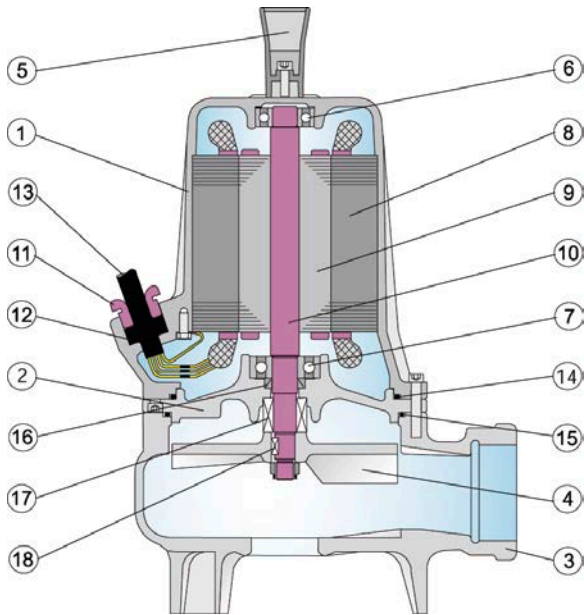

| DESCRIPTION | MATERIALS |
|---------------------------------|--------------------------|
| 1. Motor cover | Cast iron G20 |
| 2. O' Ring | Nitrilic rubber |
| 3. Motor Casing | Cast iron G20 |
| 4. Intermediate flange | |
| 5. Pump casing | |
| 6. Upper ball bearing | |
| 7. Lower ball bearing | |
| 8. Stator | |
| 9. Rotor | Stainless steal Aisi 420 |
| 10. Motor shaft | |
| 11. Lip steal | Nitrilic rubber |
| 12. Lower mech. Seal | Silicon carbide + viton |
| 13. Impeller | Cast iron G20 |
| 14. Separator cable entry gland | Nitrilic rubber |
| 15. Washer cable entry gland | Nylon |
| 16. Capacitor | |
| 17. (Cable) Grommet | Nitrilic rubber |
| 18. Cable clamp | Stainless steel Aisi 416 |
| 19. Net supply cable | H07RN8F |
| 20. Handle | Hard nylon |
| 21. Key | Stainless steel Aisi 304 |
| Bolts | Stainless steel Aisi 304 |